

IPF Industry Catalogue 2025



INDEX - BEST SELLING SPARE PARTS

	SYSTEM	PAGE
ACCESSORIES SUITABLE FOR AJAN®	HP130®/HP260® Mild steel, Stainless steel 30-260A	3
ACCESSORIES SUITABLE FOR CEBORA®	CP®200, 20-200A	4
	CP®161, 20-160A	4
ACCESSORIES SUITABLE FOR ESAB®	PT-36™, 50-600A	5
ACCESSORIES SUITABLE FOR HYPERTHERM®	Powermax® 1000/Powermax® 1250/Powermax® 1650, 40-100A	6
	Powermax® 45, Duramax™ torch, 45A	7
	Powermax® 85/Powermax® 105, Duramax™ torch, 30-105A	8
	Powermax® 125, Duramax Hyamp™ torch, 30-125A	10
	MAX200®/HT2000® Mild steel, Stainless steel 40-200A	11
	HSD130® HySpeed® Mild steel, Stainless steel 45-130A	11
	MAXPRO200®/HyPro2000® Mild steel, Stainless steel 45-200A	12
	HPR130®/HPR260® Mild steel 30-260A, Stainless steel 45-260A	13
	HPR130XD®/HPR260XD®/HPR400XD® Mild steel 30-400A	14
	HPR260XD®/HPR400XD® Mild steel Bevel 80-400A	15
	HPR130XD®/HPR260XD®/HPR400XD® Stainless steel 45-400A	16
	XPR170®/XPR300® Mild steel 30-300A	17
	XPR170®/XPR300® Stainless steel 40-300A	18
ACCESSORIES SUITABLE FOR KJELLBERG®	HiFocus 440i® PerCut®450, Mild steel 20-400A	19
	HiFocus 440i® PerCut®451, Mild steel 20-200A	20
	HiFocus 440i® PerCut®451, Mild steel 240-440A, Stainless steel 60-440A	21
	Smart Focus 400®, PerCut®4000, Mild steel 35-400A	22
ACCESSORIES SUITABLE FOR TD®	SL60-100®, 20-120A	23

INDEX - OTHER AVAILABLE SPARE PARTS

ACCESSORIES SUITABLE FOR CEBORA®	CP162C® CP251G® CP450G®
ACCESSORIES SUITABLE FOR KJELLBERG®	PA-S47W® PB-S70W® HiFocus 100® HiFocus 130® HiFocus 160i®/161i® HiFocus 160i® 3D FineFocus 800/900/1600®
ACCESSORIES SUITABLE FOR LINCOLN®	LC65/LC65M® LC105/LC105M® LC125/LC125M®

All trademarks are the property of their respective owners. IPF INDUSTRY® is an independent company and is not affiliated with or endorsed by the trademark holders mentioned. Products branded as IPF INDUSTRY® are produced by IPF INDUSTRY® or its authorized partners. Parts marked "OEM" are original components of the respective manufacturers. Some items are available only as OEM products. © 2023–2025 IPF INDUSTRY® All rights reserved.



HP130®/HP260® Mild steel, Stainless steel 30-260A



ITEM	ORDER NUMBER	DESCRIPTION	PACK.	UNIT PRICE €	
				IPF	OEM
1	IPF.SC2	Shield cap 30-260A	1		
2	IPF.S1	Shield 30A MS	1		
2	IPF.S2	Shield 40A MS	1		
2	IPF.S3	Shield 80A/130A MS	1		
2	IPF.S200	Shield 200A	1		
3	IPF.S4	Shield 260A MS	1		
3	IPF.S5	Shield 260A SS	1		
4	IPF.S6	Shield 260A Bevel	1		
4	IPF.G1	Gas ring 30-260A MS	1		
4	IPF.G2	Gas ring 30-260A SS/Al	1		
4	IPF.N1	Nozzle 30A MS	1		
4	IPF.N2	Nozzle 40A MS	1		
5	IPF.N3	Nozzle 80A MS	1		
5	IPF.N4	Nozzle 80A SS	1		
5	IPF.N5	Nozzle 130A MS	1		
6	IPF.N200	Nozzle 200A	1		
6	IPF.N6	Nozzle 130A SS/Al	1		
6	IPF.N7	Nozzle 260A MS	1		
6	IPF.N8	Nozzle 260A SS/Al	1		
6	IPF.N9	Nozzle 260A SS	1		
6	IPF.SW1	Swirl ring 30A-80A MS	1		
	IPF.SW2	Swirl ring 130A MS	1		
2	IPF.SW200	Swirl ring 200A	1		
3	IPF.SW3	Swirl ring 260A MS	1		
3	IPF.E0	Electrode 30-80A MS	5		
4	IPF.E1	Electrode 130A MS	5		
4	IPF.E3	Electrode 260A MS	5		
4	IPF.E200	Electrode 200A	5		
5	IPF.E0.SC	Electrode SC 30-80A MS (silver core)	5		
6	IPF.E1.SC	Electrode SC 130A MS (silver core)	5		
6	IPF.E3.SC	Electrode SC 260A MS (silver core)	5		
6	IPF.B1	Water tube	1		

All trademarks are the property of their respective owners. IPF INDUSTRY® is an independent company and is not affiliated with or endorsed by the trademark holders mentioned. Products branded as IPF INDUSTRY® are produced by IPF INDUSTRY® or its authorized partners. Parts marked "OEM" are original components of the respective manufacturers. Some items are available only as OEM products. © 2023–2025 IPF INDUSTRY® All rights reserved.



CP®200, 20-200A

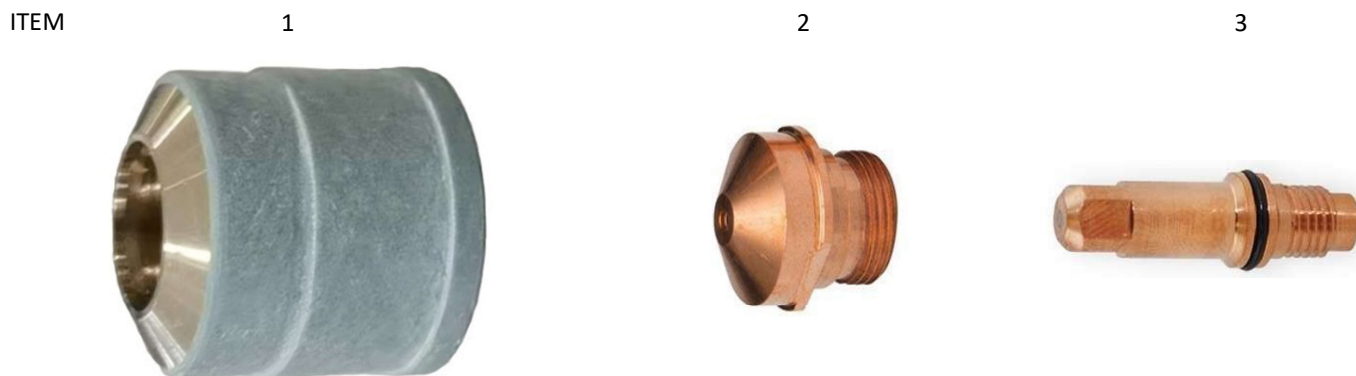

ITEM	ORDER NUMBER	DESCRIPTION	PACK.	UNIT PRICE €	
				IPF	OEM
	IPF.1386	Spacer spring	1		
1	IPF.1905	Retaining cap 20-200A	1		
2	IPF.1842	Nozzle Ø1.0, 20-50A	5		
2	IPF.1843	Nozzle Ø1.3, 40-90A	5		
2	IPF.1844	Nozzle Ø1.6, 80-120A	5		
2	IPF.1845	Nozzle Ø1.8, 110-200A	5		
3	IPF.1367	Electrode 20-200A	5		
	IPF.1357-6	Cooling tube	5		
	IPF.1357	Machine torch	1		
	IPF.1355	Hand torch 70°	1		

CP®161, 20-160A



ITEM	ORDER NUMBER	DESCRIPTION	PACK.	UNIT PRICE €	
				IPF	OEM
1	IPF.1988	Shield	1		
1	IPF.1989	Shield	1		
2	IPF.1904	Retaining cap 20-160A	1		
3	IPF.1760	Nozzle Ø1.2, 20-60A	5		
3	IPF.1761	Nozzle Ø1.4, 60-100A	5		
3	IPF.1762	Nozzle Ø1.6, 100-120A	5		
3	IPF.1763	Nozzle Ø1.8, 120-160A	5		
3	IPF.1764	Nozzle Ø3.0, 160A	5		
4	IPF.1970	Swirl ring	1		
5	IPF.1876	Electrode 20-160A	5		

All trademarks are the property of their respective owners. IPF INDUSTRY® is an independent company and is not affiliated with or endorsed by the trademark holders mentioned. Products branded as IPF INDUSTRY® are produced by IPF INDUSTRY® or its authorized partners. Parts marked "OEM" are original components of the respective manufacturers. Some items are available only as OEM products. © 2023–2025 IPF INDUSTRY® All rights reserved.

PT-36™, 50-600A



ITEM	ORDER NUMBER	DESCRIPTION	PACK.	UNIT PRICE €	
				IPF	OEM
1	IPF.37081	Shield cap 50-600A	1		
2	IPF.0558007624	Shield 2,4mm	1		
2	IPF.0558006130	Shield 3,0mm	1		
2	IPF.0558006141	Shield 4,1mm	1		
2	IPF.0558006166	Shield 6,6mm	1		
2	IPF.0558006199	Shield 9,9mm	1		
3	IPF.21944	Diffuser 50-600A	1		
4	IPF.37082	Retaining cap 50-600A	1		
5	IPF.0558009406	Nozzle 0,6mm	1		
5	IPF.0558008010	Nozzle 1,0mm	1		
5	IPF.0558006010	Nozzle 1,0mm	1		
5	IPF.0558006014	Nozzle 1,4mm	1		
5	IPF.0558006018	Nozzle 1,8mm	1		
5	IPF.0558006020	Nozzle 2,0mm	1		
5	IPF.0558006023	Nozzle 2,3mm	1		
5	IPF.0558006025	Nozzle 2,5mm	1		
5	IPF.0558006030	Nozzle 3,0mm	1		
5	IPF.0558006036	Nozzle 3,6mm	1		
5	IPF.0558006041	Nozzle 4,1mm	1		
6	IPF.0558003914.SC	Electrode SC, O2 (silver core)	5		
	IPF.0558003924	Electrode Holder	1		
	IPF.0558002533	Swirl ring, 4 holes	1		
	IPF.0558001625	Swirl ring, 8 holes	1		

All trademarks are the property of their respective owners. IPF INDUSTRY® is an independent company and is not affiliated with or endorsed by the trademark holders mentioned. Products branded as IPF INDUSTRY® are produced by IPF INDUSTRY® or its authorized partners. Parts marked "OEM" are original components of the respective manufacturers. Some items are available only as OEM products. © 2023–2025 IPF INDUSTRY® All rights reserved.



Powermax® 1000/Powermax® 1250/Powermax® 1650, 40-100A

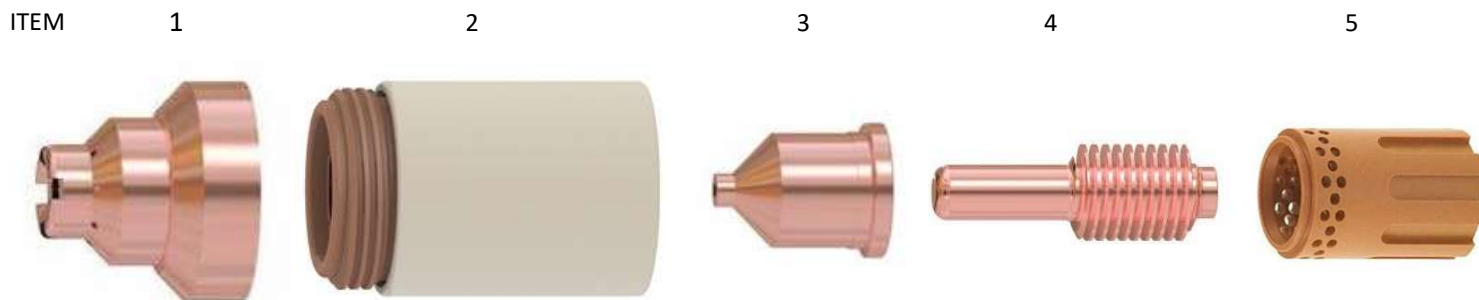

ITEM	ORDER NUMBER	DESCRIPTION	PACK.	UNIT PRICE €	
				IPF	OEM
1	IPF.120929	Shield hand 40-80A	5		
	IPF.120930	Shield machine 40-80A	5		
1	IPF.220065	Shield hand 100A	5		
	IPF.220047	Shield machine 100A	5		
	IPF.120977	Shield gouging 40-100A	5		
2	IPF.120928	Retaining cap 40-80A	1		
	IPF.220061	Retaining cap Ohmic 40-80A	1		
2	IPF.220048	Retaining cap 100A	1		
	IPF.220206	Retaining cap Ohmic 100A	1		
3	IPF.120932	Nozzle 40A	1		
	IPF.220006	Nozzle extended 40A	5		
	IPF.220329	Nozzle FC 40A	5		
3	IPF.120931	Nozzle 60A	5		
	IPF.220007	Nozzle extended 60A	5		
3	IPF.120927	Nozzle 80A	5		
3	IPF.220011	Nozzle 100A	5		
	IPF.220063	Nozzle gouging 100A	5		
4	IPF.120926	Electrode 40-80A	5		
4	IPF.120926.SC	Electrode SC 40-80A (silver core)	5		
4	IPF.220037	Electrode 100A	5		
4	IPF.220037.SC	Electrode SC 100A (silver core)	5		
5	IPF.120925	Swirl ring 80A (vespel)	1		
5	IPF.220051	Swirl ring 100A (vespel)	1		

All trademarks are the property of their respective owners. IPF INDUSTRY® is an independent company and is not affiliated with or endorsed by the trademark holders mentioned. Products branded as IPF INDUSTRY® are produced by IPF INDUSTRY® or its authorized partners. Parts marked "OEM" are original components of the respective manufacturers. Some items are available only as OEM products. © 2023–2025 IPF INDUSTRY® All rights reserved.



Powermax® 45, Duramax™ torch, 45A

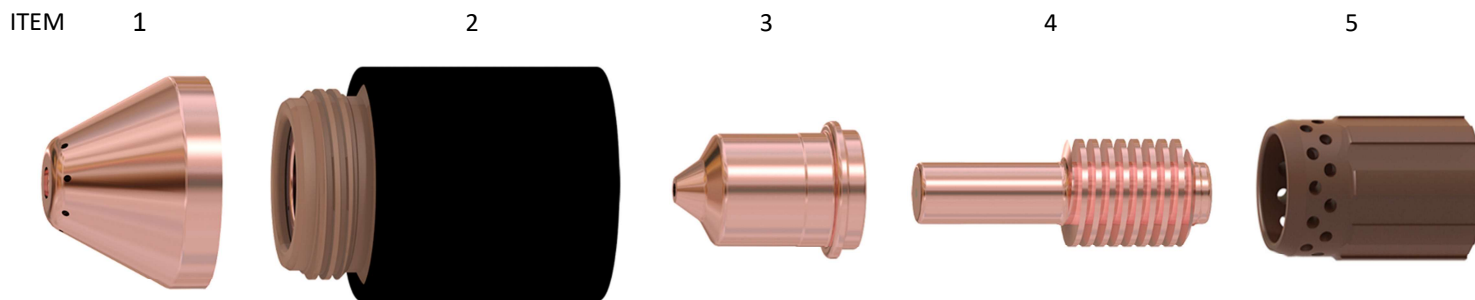

ITEM	ORDER NUMBER	DESCRIPTION	PACK.	UNIT PRICE €	
				IPF	OEM
1	IPF.220673	Shield machine 45A	5		
	IPF.220674	Shield hand 45A	5		
	IPF.220675	Shield gouging 45A	5		
	IPF.220717	Deflector 45A	5		
2	IPF.220713	Retaining cap 45A	1		
	IPF.220719	Retaining cap Ohmic 45A	1		
3	IPF.220671	Nozzle 45A	5		
	IPF.220672	Nozzle gouging 45A	5		
	IPF.220718	Nozzle extended 45A	5		
4	IPF.220669	Electrode 45A	5		
	IPF.220669.SC	Electrode SC 45A (silver core)	5		
5	IPF.220670	Swirl ring 45A	1		
	IPF.228320	Torch main body T45M	1		

All trademarks are the property of their respective owners. IPF INDUSTRY® is an independent company and is not affiliated with or endorsed by the trademark holders mentioned. Products branded as IPF INDUSTRY® are produced by IPF INDUSTRY® or its authorized partners. Parts marked "OEM" are original components of the respective manufacturers. Some items are available only as OEM products. © 2023–2025 IPF INDUSTRY® All rights reserved.



Powermax® 85/Powermax® 105, Duramax™ torch, 30-105A



ITEM	ORDER NUMBER	DESCRIPTION	PACK.	UNIT PRICE €	
				IPF	OEM
1	IPF.220818	Shield hand 45-65-85A	5		
1	IPF.220992	Shield hand 105A	5		
	IPF.220817	Shield machine 45-65-85A	5		
	IPF.220993	Shield machine 105A	5		
	IPF.220955	Deflector 45-65-85-105A	5		
	IPF.220798	Shield gouging 45-65-85-105A	5		
	IPF.420480	Shield gouging 45-65-85-105A	5		
	IPF.220931	Shield FC Hand 30-45A	5		
	IPF.220948	Shield FC Ohmic 30-45A	5		
2	IPF.220854	Retaining cap 45-65-85-105A	1		
2	IPF.220953	Retaining cap Ohmic 45-65-85-105A	1		
3	IPF.220941	Nozzle 45A	5		
3	IPF.220819	Nozzle 65A	5		
3	IPF.220816	Nozzle 85A	5		
3	IPF.220990	Nozzle 105A	5		
	IPF.220797	Nozzle gouging 45-65-85A	5		
	IPF.220991	Nozzle gouging 105A	5		
	IPF.220930	Nozzle FC 45A	5		
4	IPF.220842.SC	Electrode 45-105A (silver core)	5		
4	IPF.220777.SC	Electrode 45-105A (silver core)	5		
5	IPF.220947	Swirl ring 30-45A	1		
5	IPF.220857	Swirl ring 45-65-85A	1		
5	IPF.220994	Swirl ring 45-65-85-105A	1		
	IPF.228695	Kit PMX65/85/105/125 Air filter element	1		
	IPF.228737	Kit M65/85/105/MRT Positioning sleeve	1		
	IPF.228735	Kit M65/85/105/MRT Mounting sleeve	1		
	IPF.228716	Kit Machine torch main body PMX65-105	1		
	IPF.228736	Kit M65/85/105/MRT Adapter ring	1		
	IPF.059473	Duramax handheld torch, 75°, 7.6 m (25') lead	1		
	IPF.059474	Duramax handheld torch, 75°, 15.2 m (50') lead	1		
	IPF.059477	Duramax Machine torch, 180°, 7.6 m (25') lead	1		
	IPF.059479	Duramax Machine torch, 180°, 15.2 m (50') lead	1		

All trademarks are the property of their respective owners. IPF INDUSTRY® is an independent company and is not affiliated with or endorsed by the trademark holders mentioned. Products branded as IPF INDUSTRY® are produced by IPF INDUSTRY® or its authorized partners. Parts marked "OEM" are original components of the respective manufacturers. Some items are available only as OEM products. © 2023–2025 IPF INDUSTRY® All rights reserved.



Powermax® 125, Duramax Hyamp™ torch, 30-125A

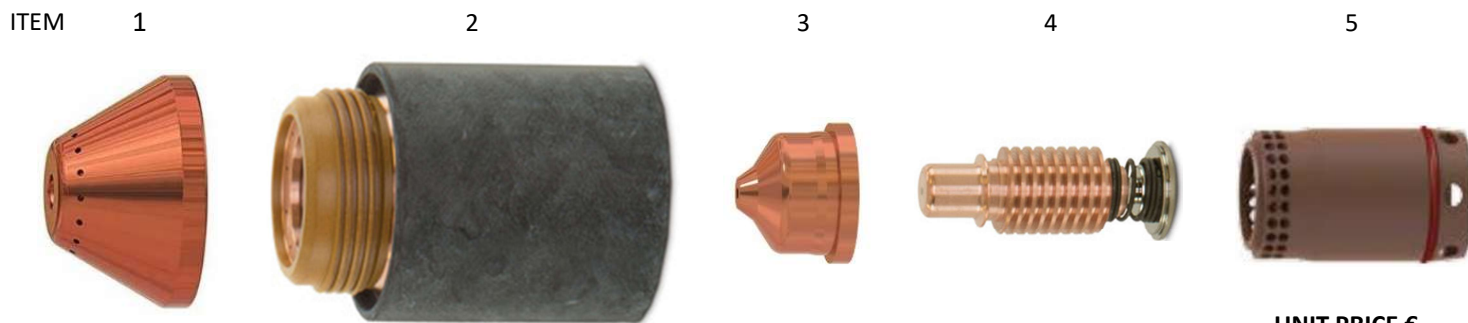

ITEM	ORDER NUMBER	DESCRIPTION	PACK.	UNIT PRICE €	
				IPF	OEM
	IPF.420172	Shield hand 45-65A	1		
	IPF.420000	Shield hand 105-125A	1		
1	IPF.420168	Shield machine 45-65A	1		
1	IPF.220976	Shield machine 105-125A	1		
	IPF.420152	Shield FC 30-45A	1		
	IPF.420112	Shield gouging 125A	1		
	IPF.420509	Shield gouging 125A	1		
2	IPF.220977	Retaining cap 30-125A	1		
2	IPF.420156	Retaining cap Ohmic 30-125A	1		
3	IPF.420158	Nozzle 45A	5		
3	IPF.420169	Nozzle 65A	5		
3	IPF.220975	Nozzle 125A	5		
3	IPF.420151	Nozzle FC 30-45A	5		
	IPF.420001	Nozzle gouging 125A	5		
4	IPF.220971.SC	Electrode SC 30-125A (OEM design, silver core)	5		
5	IPF.220997	Swirl ring 125A	1		
5	IPF.420159	Swirl ring FC 30-45A	1		
	IPF.428144	Kit Duramax Hyamp MACH POS sleeve	1		
	IPF.428145	Kit Duramax Hyamp MACH MTG sleeve	1		
	IPF.428147	Kit Duramax Hyamp MACH TCH main body repl	1		
	IPF.428248	Kit Duramax Hyamp 180° Machine torch adapter ring coupler	1		
	IPF.059492	Duramax Hyamp Handheld torch, 85°, 7.6 m (25') lead	1		
	IPF.059522	Duramax Hyamp Machine torch, 180°, 15.2 m (50') lead	1		

All trademarks are the property of their respective owners. IPF INDUSTRY® is an independent company and is not affiliated with or endorsed by the trademark holders mentioned. Products branded as IPF INDUSTRY® are produced by IPF INDUSTRY® or its authorized partners. Parts marked "OEM" are original components of the respective manufacturers. Some items are available only as OEM products. © 2023–2025 IPF INDUSTRY® All rights reserved.



MAX200®/HT2000® Mild steel, Stainless steel 40-200A

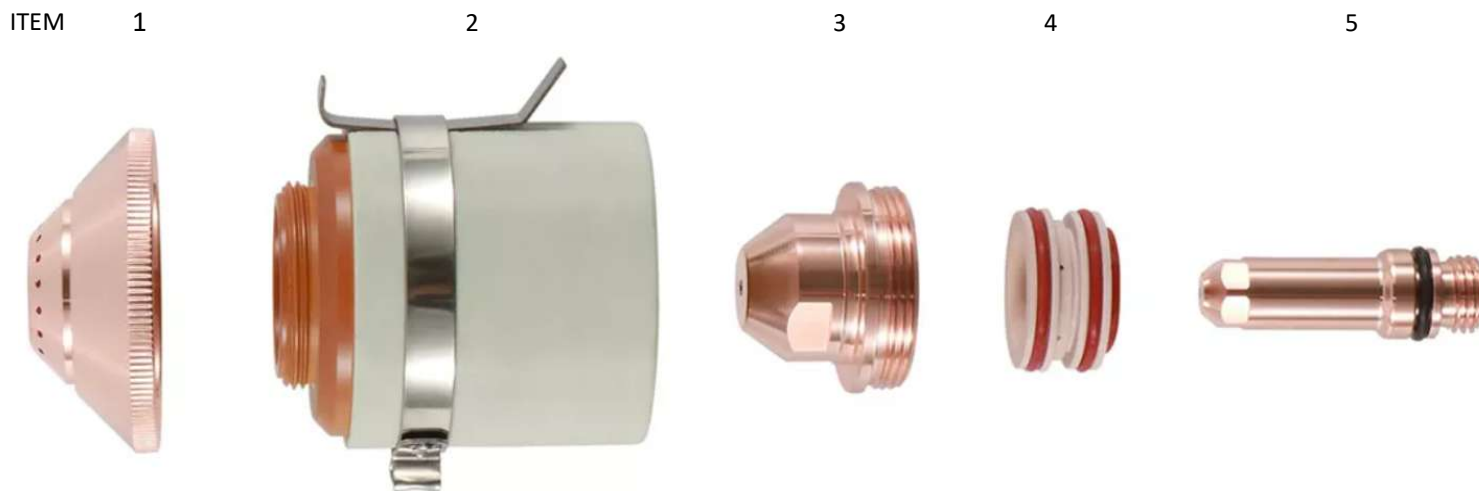

ITEM	ORDER NUMBER	DESCRIPTION	PACK.	UNIT PRICE €	
				IPF	OEM
1	IPF.020688	Shield 40A	1		
1	IPF.020448	Shield 100A	1		
1	IPF.020424	Shield 200A	1		
1	IPF.220239	Shield 200A HySpeed	1		
2	IPF.020423	Retaining cap	1		
2	IPF.120837	Retaining cap Ohmic	1		
2	IPF.220238	Retaining cap HySpeed	1		
3	IPF.020689	Nozzle 40A Air	1		
3	IPF.020611	Nozzle 100A Air, N2, Ar/H	1		
3	IPF.020608	Nozzle 200A Air, N2, Ar/H	1		
3	IPF.020616	Nozzle 100A O2	1		
3	IPF.020690	Nozzle 100A O2	1		
3	IPF.020605	Nozzle 200A O2	1		
3	IPF.220237	Nozzle 200A HySpeed	1		
4	IPF.020613	Swirl ring 40A Air	1		
4	IPF.020607	Swirl ring 100-200A Air, N2, Ar/H	1		
4	IPF.020617	Swirl ring 100A O2	1		
4	IPF.020679	Swirl ring 200A Air	1		
4	IPF.120833	Swirl ring 200A O2	1		
4	IPF.220236	Swirl ring 200A HySpeed	1		
5	IPF.120547	Electrode 100A	5		
5	IPF.120547.SC	Electrode 100A (silver core)	5		
5	IPF.220021	Electrode 200A	5		
5	IPF.220021.SC	Electrode 200A (silver core)	5		
5	IPF.120667	Electrode 40-200A	5		
5	IPF.120667.SC	Electrode 40-200A (silver core)	5		
5	IPF.020415	Electrode 100-200A N2, Ar/H	5		
5	IPF.220235	Electrode 200A HySpeed	5		
5	IPF.220235.SC	Electrode 200A HySpeed (silver core)	5		
	IPF.020693	Water tube standard	1		
	IPF.120257	Water tube extended	1		

All trademarks are the property of their respective owners. IPF INDUSTRY® is an independent company and is not affiliated with or endorsed by the trademark holders mentioned. Products branded as IPF INDUSTRY® are produced by IPF INDUSTRY® or its authorized partners. Parts marked "OEM" are original components of the respective manufacturers. Some items are available only as OEM products. © 2023–2025 IPF INDUSTRY® All rights reserved.



HSD130® HySpeed® Mild steel, Stainless steel 45-130A

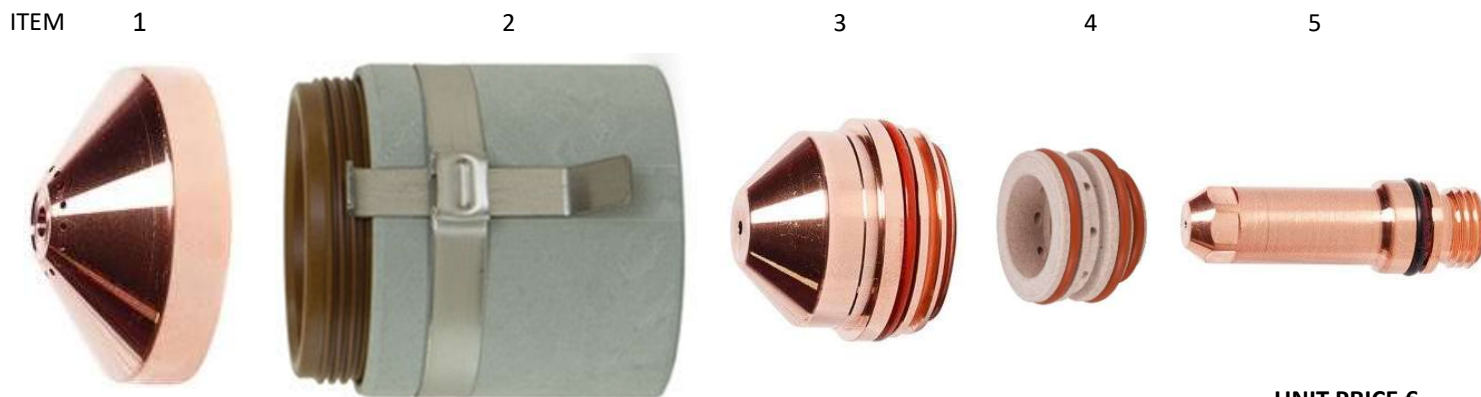

ITEM	ORDER NUMBER	DESCRIPTION	PACK.	UNIT PRICE €	
				IPF	OEM
1	IPF.220532	Shield cap 45A Air/50A O2	1		
1	IPF.220536	Shield cap 130A Air	1		
1	IPF.220491	Shield cap 130A O2	1		
2	IPF.220578	Retaining cap 45-50-130A	1		
3	IPF.220525	Nozzle 45A Air	1		
3	IPF.220530	Nozzle 45A O2	1		
3	IPF.220492	Nozzle 130A Air	1		
3	IPF.220489	Nozzle 130A O2	1		
4	IPF.220529	Swirl ring 45A Air/50A O2	1		
4	IPF.220488	Swirl ring 130A Air/130A O2	1		
5	IPF.220528	Electrode 45A Air/50A O2	5		
5	IPF.220487	Electrode 130A Air/130A O2	5		
5	IPF.220528.SC	Electrode 45A Air/50A O2 (silver core)	5		
5	IPF.220487.SC	Electrode 130A Air/130A O2 (silver core)	5		
5	IPF.020415	Electrode 100-200A N2, Ar/H	5		
	IPF.220521	Water tube 45-50-130A	1		
	IPF.220474	HSD130 Torch	1		
	IPF.027055	Silicon lubricant for o-ring, 25ml	1		
	IPF.104119	Consumables removal tool	1		

All trademarks are the property of their respective owners. IPF INDUSTRY® is an independent company and is not affiliated with or endorsed by the trademark holders mentioned. Products branded as IPF INDUSTRY® are produced by IPF INDUSTRY® or its authorized partners. Parts marked "OEM" are original components of the respective manufacturers. Some items are available only as OEM products. © 2023–2025 IPF INDUSTRY® All rights reserved.



MAXPRO200®/HyPro2000® Mild steel, Stainless steel 45-200A

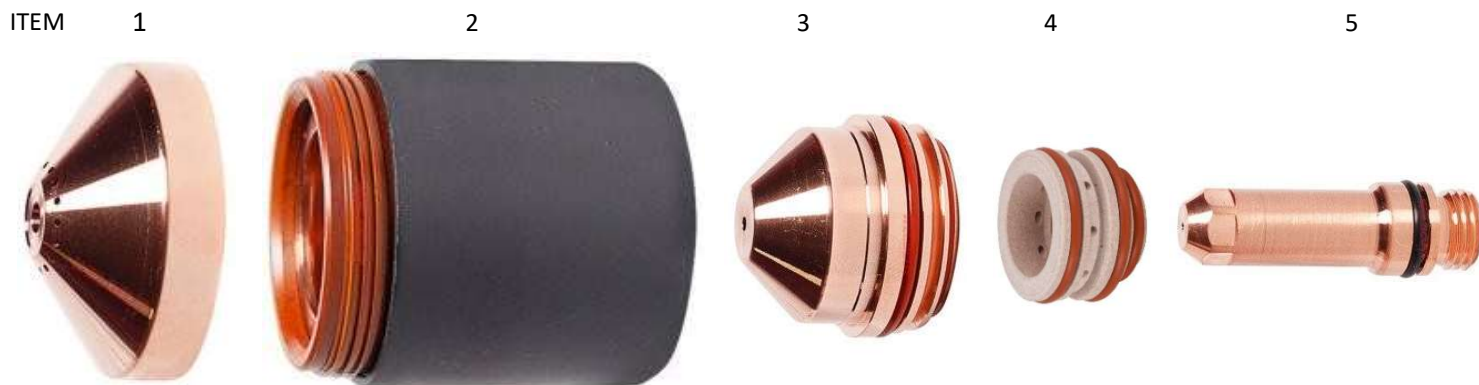

ITEM	ORDER NUMBER	DESCRIPTION	PACK.	UNIT PRICE €	
				IPF	OEM
1	IPF.220532	Shield cap 45A Air/50A O2	1		
1	IPF.220536	Shield cap 130A Air	1		
1	IPF.220491	Shield cap 130A O2	1		
1	IPF.420045	Shield cap 200A Air	1		
1	IPF.220832	Shield cap 200A O2	1		
2	IPF.220935	Retaining cap 50-130-200A	1		
	IPF.220936	Retaining cap Ohmic 50-130-200A	1		
3	IPF.220890	Nozzle 50A Air	1		
3	IPF.220892	Nozzle 130A Air	1		
3	IPF.420044	Nozzle 200A Air	1		
3	IPF.220891	Nozzle 50A O2	1		
3	IPF.220893	Nozzle 130A O2	1		
3	IPF.220831	Nozzle 200A O2	1		
4	IPF.220529	Swirl ring 45A Air/50A O2	1		
4	IPF.220488	Swirl ring 130A Air/130A O2	1		
4	IPF.220834	Swirl ring 200A Air/200A O2	1		
5	IPF.220528	Electrode 45A Air/50A O2	5		
5	IPF.220487	Electrode 130A Air/130A O2	5		
5	IPF.220937	Electrode 200A Air/200A O2	5		
5	IPF.220528.SC	Electrode 45A Air/50A O2 (silver core)	5		
5	IPF.220487.SC	Electrode 130A Air/130A O2 (silver core)	5		
5	IPF.220937.SC	Electrode 200A Air/200A O2 (silver core)	5		
5	IPF.020415	Electrode 100-200A N2, Ar/H	5		
	IPF.220521	Water tube 45-50-130A	1		
	IPF.220942	Torch mounting sleeve	1		
	IPF.220943	Mounting sleeves Ø50,8x279,4	1		
	IPF.220961	Straight torch HyPro2000	1		
	IPF.420087	Straight torch MAXPRO200	1		
	IPF.104119	Consumables removal tool	1		
	IPF.027055	Silicon lubricant for o-ring, 25ml	1		

All trademarks are the property of their respective owners. IPF INDUSTRY® is an independent company and is not affiliated with or endorsed by the trademark holders mentioned. Products branded as IPF INDUSTRY® are produced by IPF INDUSTRY® or its authorized partners. Parts marked "OEM" are original components of the respective manufacturers. Some items are available only as OEM products. © 2023–2025 IPF INDUSTRY® All rights reserved.



HPR130®/HPR260® Mild steel 30-260A, Stainless steel 45-260A

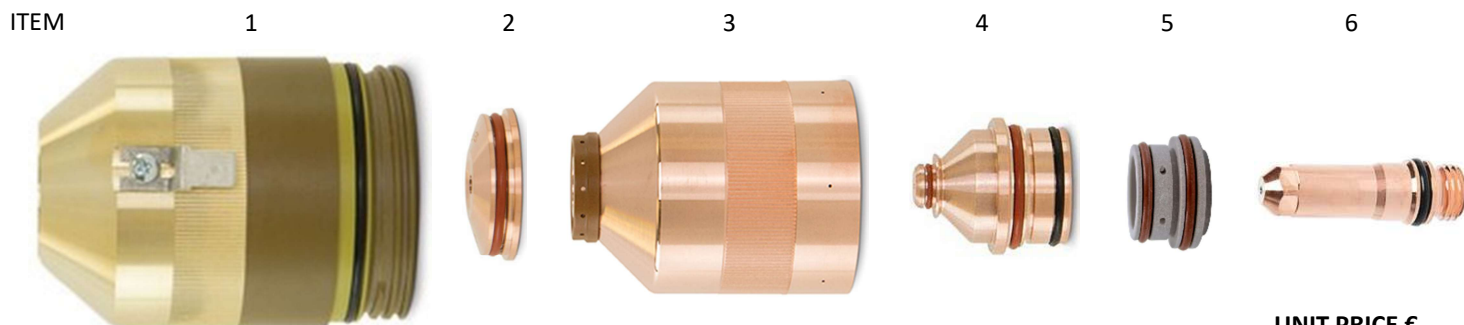

ITEM	ORDER NUMBER	DESCRIPTION	PACK.	UNIT PRICE €	
				IPF	OEM
1	IPF.220173	Shield cap 30-130A	1		
1	IPF.220398	Shield cap 200-260A	1		
2	IPF.220194	Shield 30A	1		
2	IPF.220555	Shield 50A	1		
2	IPF.220189	Shield 80A	1		
2	IPF.220183	Shield 130A	1		
2	IPF.220356	Shield 200A	1		
2	IPF.220440	Shield 260A	1		
2	IPF.220345	Shield 200A SS	1		
2	IPF.220407	Shield 260A SS	1		
3	IPF.220313	Nozzle retaining cap 30A/50A	1		
3	IPF.220176	Nozzle retaining cap 80A/130A	1		
3	IPF.220355	Nozzle retaining cap 200A	1		
3	IPF.220433	Nozzle retaining cap 260A	1		
3	IPF.220304	Retaining cap 45/80/130A SS	1		
3	IPF.220344	Retaining cap 200/260A SS	1		
4	IPF.220193.SG	Nozzle 30A Saving gas	1		
4	IPF.220554.SG	Nozzle 50A Saving gas	1		
4	IPF.220188.SG	Nozzle 80A Saving gas	1		
4	IPF.220182.SG	Nozzle 130A Saving gas	1		
4	IPF.220354.SG	Nozzle 200A Saving gas	1		
4	IPF.220439.SG	Nozzle 260A Saving gas	1		
5	IPF.220180	Swirl ring 30A	1		
5	IPF.220553	Swirl ring 50A	1		
5	IPF.220179	Swirl ring 80A/130A	1		
5	IPF.220353	Swirl ring 200A	1		
5	IPF.220436	Swirl ring 260A	1		
6	IPF.220192	Electrode 30A	5		
6	IPF.220552	Electrode 50A	5		
6	IPF.220187	Electrode 80A	5		
6	IPF.220181	Electrode 130A	5		
6	IPF.220352	Electrode 200A	5		
6	IPF.220435	Electrode 260A	5		
	IPF.220340	Water tube 30-260A	1		
	IPF.220162	Torch head HPR	1		
	IPF.220163	Torch adapter HPR	1		
	IPF.104119	Consumables removal tool	1		
	IPF.027055	Silicon lubricant for o-ring, 25ml	1		
	IPF.027664	Water filter D1.5"/38,1mm, 70-140 micron	1		

All trademarks are the property of their respective owners. IPF INDUSTRY® is an independent company and is not affiliated with or endorsed by the trademark holders mentioned. Products branded as IPF INDUSTRY® are produced by IPF INDUSTRY® or its authorized partners. Parts marked "OEM" are original components of the respective manufacturers. Some items are available only as OEM products. © 2023–2025 IPF INDUSTRY® All rights reserved.



HPR130XD®/HPR260XD®/HPR400XD® Mild steel 30-400A



ITEM	ORDER NUMBER	DESCRIPTION	PACK.	UNIT PRICE €	
				IPF	OEM
1	IPF.220747	Shield cap 30-130A	1		
1	IPF.220637	Shield cap 200-400A/Bevel 80-400A	1		
2	IPF.220194	Shield 30A	1		
2	IPF.220555	Shield 50A	1		
2	IPF.220189	Shield 80A	1		
2	IPF.220183	Shield 130A	1		
2	IPF.220761	Shield 200A	1		
2	IPF.220764	Shield 260A	1		
2	IPF.220636	Shield 400A/Bevel 400A	1		
3	IPF.220754	Retaining cap 30A/50A	1		
3	IPF.220756	Retaining cap 80A/130A	1		
3	IPF.220757	Retaining cap 200A	1		
3	IPF.220760	Retaining cap 260A	1		
3	IPF.220635	Retaining cap 400A/Bevel 400A	1		
4	IPF.220193	Nozzle 30A	1		
4	IPF.220554	Nozzle 50A	1		
4	IPF.220188	Nozzle 80A	1		
4	IPF.220182	Nozzle 130A	1		
4	IPF.220354	Nozzle 200A	1		
4	IPF.220439	Nozzle 260A	1		
	IPF.220632	Nozzle 400A/Bevel 400A	1		
5	IPF.220180	Swirl ring 30A	1		
5	IPF.220553	Swirl ring 50A	1		
5	IPF.220179	Swirl ring 80A/130A	1		
5	IPF.220353	Swirl ring 200A	1		
5	IPF.220436	Swirl ring 260A	1		
	IPF.220631	Swirl ring 400A	1		
6	IPF.220192.SC	Electrode 30A (silver core)	5		
6	IPF.220552.SC	Electrode 50A (silver core)	5		
6	IPF.220187.SC	Electrode 80A (silver core)	5		
6	IPF.220181.SC	Electrode 130A (silver core)	5		
6	IPF.220352.SC	Electrode 200A (silver core)	5		
6	IPF.220435.SC	Electrode 260A (silver core)	5		
	IPF.220629.SC	Electrode 400A/Bevel 400A (silver core)	5		
	IPF.220340	Water tube 30-260A	1		
	IPF.220571	Water tube 400A/Bevel 200-260A	1		
	IPF.220705	Quick-disconnect receptacle	1		
	IPF.220706	HyPerformance HPRXD torch	1		
	IPF.104119	Consumables removal tool	1		
	IPF.027055	Silicon lubricant for o-ring, 25ml	1		
	IPF.027664	Water filter D1.5"/38,1mm, 70-140 micron	1		

All trademarks are the property of their respective owners. IPF INDUSTRY® is an independent company and is not affiliated with or endorsed by the trademark holders mentioned. Products branded as IPF INDUSTRY® are produced by IPF INDUSTRY® or its authorized partners. Parts marked "OEM" are original components of the respective manufacturers. Some items are available only as OEM products. © 2023–2025 IPF INDUSTRY® All rights reserved.



HPR260XD®/HPR400XD® Mild steel Bevel 80-400A



ITEM	ORDER NUMBER	DESCRIPTION	PACK.	UNIT PRICE €	
				IPF	OEM
1	IPF.220637	Shield cap 200-400A/Bevel 80-400A	1		
2	IPF.220742	Shield Bevel 80A/130A	1		
2	IPF.220658	Shield Bevel 200A	1		
2	IPF.220741	Shield Bevel 260A	1		
2	IPF.220636	Shield 400A/Bevel 400A	1		
3	IPF.220845	Retaining cap Bevel 80A/200A	1		
3	IPF.220740	Retaining cap Bevel 130A/260A	1		
3	IPF.220635	Retaining cap 400A/Bevel 400A	1		
4	IPF.220806	Nozzle Bevel 80A	1		
4	IPF.220646	Nozzle Bevel 130A	1		
4	IPF.220659	Nozzle Bevel 200A	1		
4	IPF.220542	Nozzle Bevel 260A	1		
4	IPF.220632	Nozzle 400A/Bevel 400A	1		
5	IPF.220179	Swirl ring 80A/130A	1		
5	IPF.220353	Swirl ring 200A	1		
5	IPF.220436	Swirl ring 260A	1		
5	IPF.220631	Swirl ring 400A	1		
6	IPF.220802.SC	Electrode Bevel 80A (silver core)	5		
6	IPF.220649.SC	Electrode Bevel 130A (silver core)	5		
6	IPF.220662.SC	Electrode Bevel 200A (silver core)	5		
6	IPF.220541.SC	Electrode Bevel 260A (silver core)	5		
6	IPF.220629.SC	Electrode 400A/Bevel 400A (silver core)	5		
	IPF.220700	Water tube Bevel 80-200A	1		
	IPF.220571	Water tube 400A/Bevel 200-260A	1		
	IPF.220705	Quick-disconnect receptacle	1		
	IPF.220706	HyPerformance HPRXD torch	1		
	IPF.104119	Consumables removal tool	1		
	IPF.027055	Silicon lubricant for o-ring, 25ml	1		
	IPF.027664	Water filter D1.5"/38,1mm, 70-140 micron	1		

All trademarks are the property of their respective owners. IPF INDUSTRY® is an independent company and is not affiliated with or endorsed by the trademark holders mentioned. Products branded as IPF INDUSTRY® are produced by IPF INDUSTRY® or its authorized partners. Parts marked "OEM" are original components of the respective manufacturers. Some items are available only as OEM products. © 2023–2025 IPF INDUSTRY® All rights reserved.



HPR130XD®/HPR260XD®/HPR400XD® Stainless steel 45-400A

IPF

1

2

3

4

5

6



ITEM	ORDER NUMBER	DESCRIPTION	PACK.	UNIT PRICE €	
				IPF	OEM
1	IPF.220747	Shield cap 30-130A	1		
1	IPF.220637	Shield cap 200-400A/Bevel 80-400A	1		
2	IPF.220202	Shield 45A SS/AL	1		
2	IPF.220338	Shield 80A SS	1		
2	IPF.220198	Shield 130A SS/AL	1		
2	IPF.220762	Shield 200A SS/AL	1		
2	IPF.220763	Shield 260A SS/AL	1		
2	IPF.220707	Shield 400A SS/AL	1		
2	IPF.220738	Shield Bevel 130-260A SS/AL	1		
3	IPF.220755	Retaining cap 45-80-130A SS	1		
3	IPF.220756	Retaining cap 80A/130A	1		
3	IPF.220758	Retaining cap 200-260A SS/AL	1		
3	IPF.220759	Retaining cap 200A AL	1		
3	IPF.220712	Retaining cap 400A SS/AL	1		
3	IPF.220739	Retaining cap Bevel 130/260A SS	1		
4	IPF.220201	Nozzle 45A SS/AL	1		
4	IPF.220337	Nozzle 80A SS	1		
4	IPF.220197	Nozzle 130A SS/AL	1		
4	IPF.220343	Nozzle 200A SS	1		
4	IPF.220346	Nozzle 200A AL	1		
4	IPF.220406	Nozzle 260A SS/AL	1		
4	IPF.220708	Nozzle 400A SS/AL	1		
4	IPF.220656	Nozzle Bevel 130A SS	1		
4	IPF.220607	Nozzle Bevel 260A SS	1		
4	IPF.220708	Nozzle 400A SS/AL	1		
5	IPF.220180	Swirl ring 30A	1		
5	IPF.220179	Swirl ring 80A/130A	1		
5	IPF.220342	Swirl ring 200A SS/AL	1		
5	IPF.220405	Swirl ring 260A/400A SS/AL	1		
6	IPF.220308	Electrode 45A SS/AL	5		
6	IPF.220339	Electrode 80A SS/AL	5		
6	IPF.220307	Electrode 130-200-260A SS/AL	5		
6	IPF.220709	Electrode 400A SS/AL	5		
6	IPF.220606	Electrode Bevel 130-260A SS	5		
	IPF.220340	Water tube 30-260A	1		
	IPF.220571	Water tube 400A/Bevel 200-260A	1		
	IPF.220705	Quick-disconnect receptacle	1		
	IPF.220706	HyPerformance HPRXD torch	1		
	IPF.104119	Consumables removal tool	1		
	IPF.027055	Silicon lubricant for o-ring, 25ml	1		
	IPF.027664	Water filter D1.5"/38,1mm, 70-140 micron	1		

All trademarks are the property of their respective owners. IPF INDUSTRY® is an independent company and is not affiliated with or endorsed by the trademark holders mentioned. Products branded as IPF INDUSTRY® are produced by IPF INDUSTRY® or its authorized partners. Parts marked "OEM" are original components of the respective manufacturers. Some items are available only as OEM products. © 2023–2025 IPF INDUSTRY® All rights reserved.



XPR170®/XPR300® Mild steel 30-300A

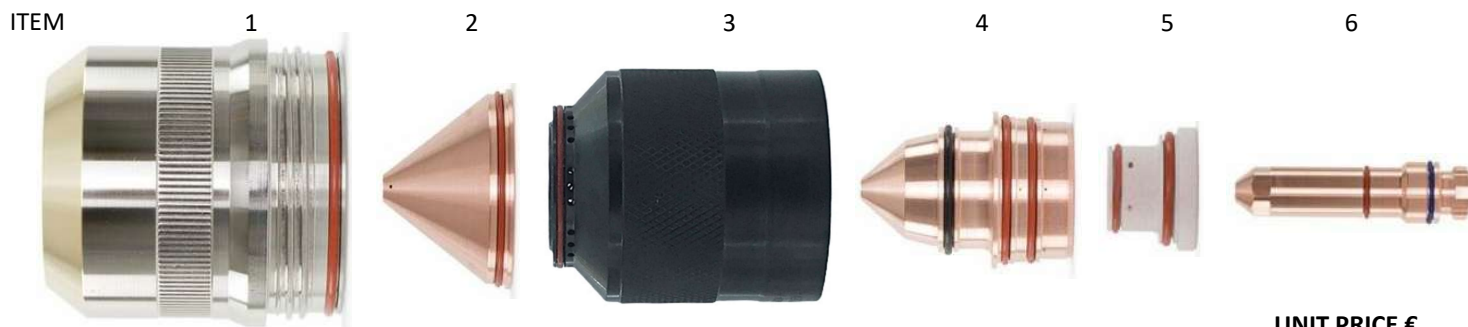

ITEM	ORDER NUMBER	DESCRIPTION	PACK.	UNIT PRICE €	
				IPF	OEM
1	IPF.420200	Shield cap	1		
2	IPF.420228	Shield 30A	1		
2	IPF.420237	Shield 50A	1		
2	IPF.420246	Shield 80A	1		
2	IPF.420255	Shield 130A	1		
2	IPF.420513	Shield 170A	1		
2	IPF.420273	Shield 220A	1		
2	IPF.420491	Shield 300A	1		
3	IPF.420365	Retaining cap	1		
4	IPF.420225	Nozzle 30A	1		
4	IPF.420234	Nozzle 50A	1		
4	IPF.420243	Nozzle 80A	1		
4	IPF.420252	Nozzle 130A	1		
4	IPF.420261	Nozzle 170A	1		
4	IPF.420270	Nozzle 220A	1		
4	IPF.420279	Nozzle 300A	1		
5	IPF.420407	Swirl ring 30A	1		
5	IPF.420233	Swirl ring 50A	1		
5	IPF.420242	Swirl ring 80/130A	1		
5	IPF.420260	Swirl ring 170A	1		
5	IPF.420406	Swirl ring 220/300A	1		
6	IPF.420222.SC	Electrode SC 30A (silver core)	5		
6	IPF.420231.SC	Electrode SC 50A (silver core)	5		
6	IPF.420240.SC	Electrode SC 80A (silver core)	5		
6	IPF.420249.SC	Electrode SC 130A (silver core)	5		
6	IPF.420258.SC	Electrode SC 170A (silver core)	5		
6	IPF.420276.SC	Electrode SC 220/300A (silver core)	5		
	IPF.420368	Water tube	1		
	IPF.420220	Quick-disconnect receptacle	1		
	IPF.420221	Head XPR torch	1		
	IPF.104119	Consumables removal tool	1		
	IPF.027055	Silicon lubricant for o-ring, 25ml	1		

All trademarks are the property of their respective owners. IPF INDUSTRY® is an independent company and is not affiliated with or endorsed by the trademark holders mentioned. Products branded as IPF INDUSTRY® are produced by IPF INDUSTRY® or its authorized partners. Parts marked "OEM" are original components of the respective manufacturers. Some items are available only as OEM products. © 2023–2025 IPF INDUSTRY® All rights reserved.



XPR170®/XPR300® Stainless steel 40-300A

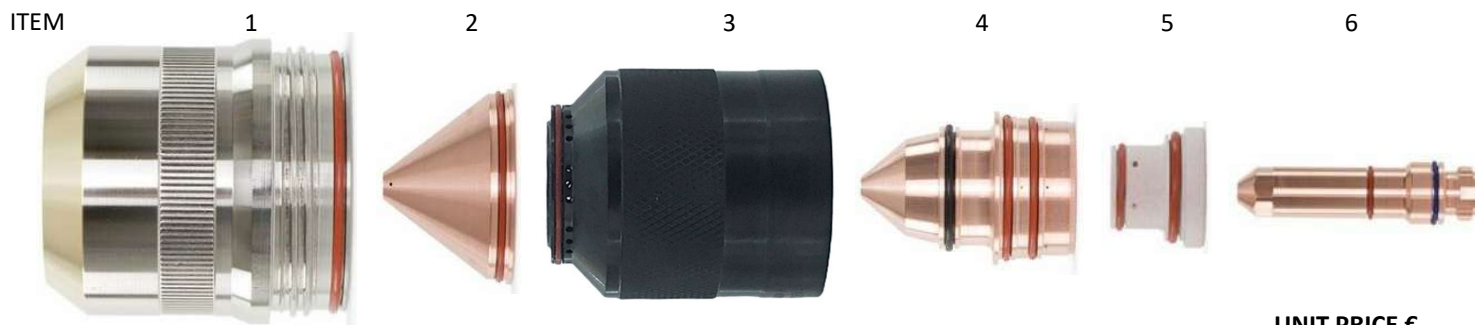

ITEM	ORDER NUMBER	DESCRIPTION	PACK.	UNIT PRICE €	
				IPF	OEM
1	IPF.420200	Shield cap	1		
2	IPF.420291	Shield 40A	1		
2	IPF.420309	Shield 60-80A	1		
2	IPF.420318	Shield 130A	1		
2	IPF.420327	Shield 170A	1		
2	IPF.420513	Shield 170A	1		
2	IPF.420362	Shield 300A	1		
3	IPF.420365	Retaining cap	1		
4	IPF.420288	Nozzle 40A	1		
4	IPF.420297	Nozzle 60A	1		
4	IPF.420306	Nozzle 80A	1		
4	IPF.420315	Nozzle 130A	1		
4	IPF.420324	Nozzle 170A	1		
4	IPF.420524	Nozzle 170A	1		
4	IPF.420359	Nozzle 300A	1		
5	IPF.420314	Swirl ring 40/130/170A	1		
5	IPF.420323	Swirl ring 60/80/130/170/300A	1		
5	IPF.420260	Swirl ring 170A	1		
6	IPF.420303	Electrode 40-80A	5		
6	IPF.420356	Electrode 130-300A	5		
6	IPF.420258.SC	Electrode SC 170A (silver core)	5		
	IPF.420368	Water tube	1		
	IPF.420220	Quick-disconnect receptacle	1		
	IPF.420221	Head XPR torch	1		
	IPF.104119	Consumables removal tool	1		
	IPF.027055	Silicon lubricant for o-ring, 25ml	1		

All trademarks are the property of their respective owners. IPF INDUSTRY® is an independent company and is not affiliated with or endorsed by the trademark holders mentioned. Products branded as IPF INDUSTRY® are produced by IPF INDUSTRY® or its authorized partners. Parts marked "OEM" are original components of the respective manufacturers. Some items are available only as OEM products. © 2023–2025 IPF INDUSTRY® All rights reserved.



HiFocus 440i® PerCut®450, Mild steel 20-400A



ITEM	ORDER NUMBER	DESCRIPTION	PACK.	UNIT PRICE €	
				IPF	OEM
1	IPF.11.848.201.081	Shield cap G501	1		
1	IPF.11.848.401.081	Shield cap G521	1		
2	IPF.11.848.201.1515	Shield G4015	5		
2	IPF.11.848.201.1520	Shield G4020	5		
2	IPF.11.848.201.1522	Shield G4022	5		
2	IPF.11.848.201.1525	Shield G4025	5		
2	IPF.11.848.201.1530	Shield G4030	5		
2	IPF.11.848.401.1550	Shield G4350	5		
2	IPF.11.848.401.1555	Shield G4355	5		
3	IPF.11.848.201.1604	Retaining cap G3004	1		
3	IPF.11.848.201.1628	Retaining cap G3028	1		
3	IPF.11.848.401.1609	Retaining cap G3209	1		
3	IPF.11.848.401.1619	Retaining cap G3219	1		
3	IPF.11.848.401.1629	Retaining cap G3229	1		
3	IPF.11.848.401.1649	Retaining cap G3249	1		
4	IPF.11.848.221.406	Nozzle G2006Y	5		
4	IPF.11.848.221.407	Nozzle G2007Y	5		
4	IPF.11.848.221.408	Nozzle G2008Y	5		
4	IPF.11.848.221.410	Nozzle G2010Y	5		
4	IPF.11.848.221.412	Nozzle G2012Y	5		
4	IPF.11.848.221.414	Nozzle G2014Y	5		
4	IPF.11.848.221.416	Nozzle G2016Y	5		
4	IPF.11.848.421.426	Nozzle G2326Y	5		
4	IPF.11.848.421.430	Nozzle G2330Y	5		
4	IPF.11.848.421.431	Nozzle G2331Y	5		
5	IPF.11.848.221.145	Swirl ring G101 (vespel)	1		
5	IPF.11.848.221.146	Swirl ring G102 (vespel)	1		
5	IPF.11.848.421.145	Swirl ring G121 (vespel)	1		
6	IPF.11.848.221.300.ST	Cathode G002Y (silver top)	5		
6	IPF.11.848.221.300.SC	Cathode G002Y (silver core)	5		
6	IPF.11.848.221.310.SC	Cathode G003Y (silver core)	5		
6	IPF.11.848.421.310.ST	Cathode G032Y (silver top)	5		
6	IPF.11.848.421.310.SC	Cathode G032Y (silver core)	5		
6	IPF.11.848.421.330.ST	Cathode G034Y (silver top)	5		
6	IPF.11.848.421.330.SC	Cathode G034Y (silver core)	5		
7	IPF.11.848.201.142	Cooling tube G901Y	1		
7	IPF.11.848.401.142	Cooling tube G931Y	1		
	IPF.11.848.401.810	Torch Multitool	1		
	IPF.12.62340	COOLANT LIQUID, -25°C / 10l (2x 5l)	1		

All trademarks are the property of their respective owners. IPF INDUSTRY® is an independent company and is not affiliated with or endorsed by the trademark holders mentioned. Products branded as IPF INDUSTRY® are produced by IPF INDUSTRY® or its authorized partners. Parts marked "OEM" are original components of the respective manufacturers. Some items are available only as OEM products. © 2023–2025 IPF INDUSTRY® All rights reserved.



Sales representative
EMEA

Věnceslav Chumchal
veneslav@ipf-industry.com
+420 777124287



HiFocus 440i® PerCut®451, Mild steel 20-200A



ITEM	ORDER NUMBER	DESCRIPTION	PACK.	UNIT PRICE €	
				IPF	OEM
1	IPF.11.852.201.081	Shield cap G502	1		
1	IPF.11.848.201.1515	Shield G4015	5		
2	IPF.11.848.201.1520	Shield G4020	5		
2	IPF.11.848.201.1522	Shield G4022	5		
2	IPF.11.848.201.1525	Shield G4025	5		
2	IPF.11.848.201.1530	Shield G4030	5		
2	IPF.11.848.201.1535	Shield G4035	5		
2	IPF.11.848.201.1540	Shield G4040	5		
2	IPF.11.848.201.1604	Retaining cap G3004	1		
3	IPF.11.848.201.1608	Retaining cap G3008	1		
3	IPF.11.848.201.1618	Retaining cap G3018	1		
3	IPF.11.848.201.1628	Retaining cap G3028	1		
3	IPF.11.848.201.1648	Retaining cap G3048	1		
3	IPF.11.848.221.406	Nozzle G2006Y	5		
4	IPF.11.848.221.407	Nozzle G2007Y	5		
4	IPF.11.848.221.408	Nozzle G2008Y	5		
4	IPF.11.848.221.408S	Nozzle G2008S	5		
4	IPF.11.848.221.410	Nozzle G2010Y	5		
4	IPF.11.848.221.410S	Nozzle G2010S	5		
4	IPF.11.848.221.412	Nozzle G2012Y	5		
4	IPF.11.848.221.412S	Nozzle G2012S	5		
4	IPF.11.848.221.414	Nozzle G2014Y	5		
4	IPF.11.848.221.414S	Nozzle G2014S	5		
4	IPF.11.848.221.416	Nozzle G2016Y	5		
4	IPF.11.848.221.417	Nozzle G2017Y	5		
4	IPF.11.848.221.145	Swirl ring G101 (vespel)	1		
5	IPF.11.848.221.145C	Swirl ring G101C (ceramic)	1		
5	IPF.11.848.221.146	Swirl ring G102 (vespel)	1		
5	IPF.11.848.221.147	Swirl ring G103 (vespel)	1		
5	IPF.11.848.221.148	Swirl ring G104 (vespel)	1		
5	IPF.11.848.221.149	Swirl ring G105 (vespel)	1		
5	IPF.11.848.231.320.SC	Cathode G011Y (silver core)	5		
6	IPF.11.848.231.350.SC	Cathode G015Y (silver core)	5		
6	IPF.11.848.231.360.SC	Cathode G016Y (silver core)	5		
6	IPF.11.852.201.142	Cooling tube G902Y	1		
6	IPF.11.848.401.810	Torch Multitool	1		
6	IPF.12.62340	COOLANT LIQUID, -25°C / 10l (2x 5l)	1		
	IPF.11.853.421.100	Torch head PerCut 211M	1		
	IPF.11.852.421.100	Torch head PerCut 451M	1		

All trademarks are the property of their respective owners. IPF INDUSTRY® is an independent company and is not affiliated with or endorsed by the trademark holders mentioned. Products branded as IPF INDUSTRY® are produced by IPF INDUSTRY® or its authorized partners. Parts marked "OEM" are original components of the respective manufacturers. Some items are available only as OEM products. © 2023–2025 IPF INDUSTRY® All rights reserved.



Sales representative
EMEA

Věnceslav Chumchal
veneslav@ipf-industry.com
+420 777124287



HiFocus 440i® PerCut®451, Mild steel 240-440A, Stainless steel 60-440A



ITEM	ORDER NUMBER	DESCRIPTION	PACK.	UNIT PRICE €	
				IPF	OEM
1	IPF.11.852.401.081	Shield cap G522	1		
2	IPF.11.848.401.1535	Shield G4335	5		
2	IPF.11.848.401.1540	Shield G4340	5		
2	IPF.11.848.401.1545	Shield G4345	5		
2	IPF.11.848.401.1550	Shield G4350	5		
2	IPF.11.848.401.1555	Shield G4355	5		
3	IPF.11.848.401.1608	Retaining cap G3208	1		
3	IPF.11.848.401.1609	Retaining cap G3209	1		
3	IPF.11.848.401.1618	Retaining cap G3218	1		
3	IPF.11.848.401.1619	Retaining cap G3219	1		
3	IPF.11.848.401.1628	Retaining cap G3228	1		
3	IPF.11.848.401.1629	Retaining cap G3229	1		
3	IPF.11.848.401.1648	Retaining cap G3248	1		
3	IPF.11.848.401.1649	Retaining cap G3249	1		
4	IPF.11.848.421.426	Nozzle G2326Y	5		
4	IPF.11.848.421.430	Nozzle G2330Y	5		
4	IPF.11.848.421.431	Nozzle G2331Y	5		
4	IPF.11.848.311.614	Nozzle G2514	5		
4	IPF.11.848.311.615	Nozzle G2515	5		
4	IPF.11.848.311.616	Nozzle G2516	5		
4	IPF.11.848.311.618	Nozzle G2518	5		
4	IPF.11.848.411.625	Nozzle G2725	5		
4	IPF.11.848.411.627	Nozzle G2727	5		
4	IPF.11.848.411.629	Nozzle G2729	5		
5	IPF.11.848.421.145	Swirl ring G121 (vespel)	1		
5	IPF.11.848.421.149	Swirl ring G125 (vespel)	1		
6	IPF.11.848.421.310.ST	Cathode G032Y (silver top)	5		
6	IPF.11.848.421.330.ST	Cathode G034Y (silver top)	5		
6	IPF.11.848.421.310.SC	Cathode G032Y (silver core)	5		
6	IPF.11.848.421.330.SC	Cathode G034Y (silver core)	5		
6	IPF.11.848.401.310	Cathode G092Y (Cu)	5		
6	IPF.11.848.401.310.SC	Cathode G092Y (silver core)	5		
6	IPF.11.848.211.510+	Cathode G042+ Ar/H2	5		
6	IPF.11.848.211.530	Cathode G044 N2	5		
6	IPF.11.848.311.510	Cathode G052	5		
6	IPF.11.848.411.500	Cathode G071 Ar/H2	5		
6	IPF.11.848.411.520	Cathode G073 Ar/H2	5		
7	IPF.11.848.401.142	Cooling tube G931Y	1		
7	IPF.11.848.211.142	Cooling tube G941Y	1		
7	IPF.11.848.411.142	Cooling tube G971	1		

All trademarks are the property of their respective owners. IPF INDUSTRY® is an independent company and is not affiliated with or endorsed by the trademark holders mentioned. Products branded as IPF INDUSTRY® are produced by IPF INDUSTRY® or its authorized partners. Parts marked "OEM" are original components of the respective manufacturers. Some items are available only as OEM products. © 2023–2025 IPF INDUSTRY® All rights reserved.



Smart Focus 400®, PerCut®4000, Mild steel 35-400A



ITEM	ORDER NUMBER	DESCRIPTION	PACK.	UNIT PRICE €	
				IPF	OEM
1	IPF.11.855.401.081	Shield cap F501	1		
1	IPF.11.855.421.081	Shield cap F521	1		
2	IPF.11.855.411.1520	Shield F4120	5		
2	IPF.11.855.401.1520	Shield F4020	5		
2	IPF.11.855.401.1530	Shield F4030	5		
2	IPF.11.855.401.1535	Shield F4035	5		
2	IPF.11.855.401.1540	Shield F4040	5		
2	IPF.11.855.421.1550	Shield F4250	5		
2	IPF.11.855.421.1555	Shield F4255	5		
3	IPF.11.855.401.1604	Retaining cap F3004	1		
3	IPF.11.855.401.1628	Retaining cap F3028	1		
3	IPF.11.855.421.1619	Retaining cap F3219	1		
3	IPF.11.855.421.1609	Retaining cap F3209	1		
3	IPF.11.855.421.1629	Retaining cap F3229	1		
3	IPF.11.855.421.1649	Retaining cap F3249	1		
4	IPF.11.855.401.407	Nozzle 0.7mm F2007	5		
4	IPF.11.855.401.408	Nozzle 0.8mm F2008	5		
4	IPF.11.855.401.410	Nozzle 1.0mm F2010	5		
4	IPF.11.855.401.412	Nozzle 1.2mm F2012	5		
4	IPF.11.855.401.414	Nozzle 1.4mm F2014	5		
4	IPF.11.855.401.417	Nozzle 1.7mm F2017	5		
4	IPF.11.855.421.427	Nozzle 2.7mm F2227	5		
4	IPF.11.855.421.430	Nozzle 3.0mm F2230	5		
4	IPF.11.855.421.431	Nozzle 3.1mm F2231	5		
5	IPF.11.848.221.145C	Swirl ring G101C (ceramic)	1		
5	IPF.11.848.421.145C	Swirl ring G121C (ceramic)	1		
6	IPF.11.855.411.320.SC	Cathode F012 (silver core)	5		
6	IPF.11.855.401.350.SC	Cathode F005 (silver core)	5		
6	IPF.11.855.401.360.SC	Cathode F006 (silver core)	5		
6	IPF.11.855.421.320.SC	Cathode F022 (silver core)	5		
6	IPF.11.855.421.340.SC	Cathode F024 (silver core)	5		
7	IPF.11.855.401.142	Cooling tube F902	1		
7	IPF.11.855.421.141	Cooling tube F921	1		
	IPF.12.62340	COOLANT LIQUID, -25°C / 10l (2x 5l)	1		

All trademarks are the property of their respective owners. IPF INDUSTRY® is an independent company and is not affiliated with or endorsed by the trademark holders mentioned. Products branded as IPF INDUSTRY® are produced by IPF INDUSTRY® or its authorized partners. Parts marked "OEM" are original components of the respective manufacturers. Some items are available only as OEM products. © 2023–2025 IPF INDUSTRY® All rights reserved.



SL60-100®, 20-120A



ITEM	ORDER NUMBER	DESCRIPTION	PACK.	UNIT PRICE €	
				IPF	OEM
1	IPF.9-8251	Standoff guide	2		
1	IPF.9-8281	Standoff guide	2		
	IPF.9-8259	Ohmic clip manual	1		
	IPF.9-8224	Ohmic clip automation	1		
	IPF.9-8241	Shield 40A-120A gouging	5		
	IPF.9-8243	Shield 40A-120A cutting standoff	5		
	IPF.9-8244	Shield 40A cutting drag	5		
	IPF.9-8235	Shield 50A-60A cutting drag	5		
	IPF.9-8236	Shield 70A-100A cutting drag	5		
	IPF.9-8258	Shield 120A cutting drag	5		
2	IPF.9-8245	Shield 40A cutting machine	5		
2	IPF.9-8238	Shield 50A-60A cutting machine	5		
2	IPF.9-8239	Shield 70A-100A cutting machine	5		
2	IPF.9-8256	Shield 120A cutting machine	5		
3	IPF.9-8218	Retaining cap 20A-120A	1		
3	IPF.9-8237	Retaining cap 20A-120A MaximumLife	1		
	IPF.9-8205	Nozzle 20A drag	10		
	IPF.9-8206	Nozzle 30A drag	10		
	IPF.9-8207	Nozzle 40A drag	10		
	IPF.9-8252	Nozzle 60A drag	10		
4	IPF.9-8208	Nozzle 40A cutting standoff	10		
4	IPF.9-8209	Nozzle 50A-55A cutting standoff	10		
4	IPF.9-8210	Nozzle 60A cutting standoff	10		
4	IPF.9-8231	Nozzle 70A cutting standoff	10		
4	IPF.9-8211	Nozzle 80A cutting standoff	10		
4	IPF.9-8212	Nozzle 90A-100A cutting standoff	10		
	IPF.9-8233	Nozzle 120A cutting auto	10		
	IPF.9-8253	Nozzle 120A cutting standoff	10		
	IPF.9-8225	Nozzle 40A gouging "A"	10		
	IPF.9-8226	Nozzle 60A gouging "B"	10		
	IPF.9-8227	Nozzle 80A gouging "C"	10		
	IPF.9-8228	Nozzle 100A gouging "D"	10		
	IPF.9-8254	Nozzle 120A gouging "E"	10		
5	IPF.9-8213	Start cartridge	1		
5	IPF.9-8277	Start cartridge	1		
6	IPF.9-8215	Electrode 20-120A	10		
6	IPF.9-8215.SC	Electrode 20-120A (silver core)	10		
6	IPF.9-8232	Electrode 20-120A	10		

All trademarks are the property of their respective owners. IPF INDUSTRY® is an independent company and is not affiliated with or endorsed by the trademark holders mentioned. Products branded as IPF INDUSTRY® are produced by IPF INDUSTRY® or its authorized partners. Parts marked "OEM" are original components of the respective manufacturers. Some items are available only as OEM products. © 2023–2025 IPF INDUSTRY® All rights reserved.

